

Ponteggio a boccole C.P.1 FAST

Scaffold with bushings C.P.1 FAST

Échafaudage avec cadre à douilles C.P.1 FAST

Descrizione

Ponteggio a telai prefabbricati a boccole, costruito con materiali certificati e sotto stretto controllo qualitativo. La partenza stretta del nostro ponteggio è di soli 35 cm, garantendone così un semplice utilizzo anche negli spazi più angusti e nei vicoli più stretti.

I terminali da 1 e 2 m hanno rinforzo inferiore con giunto e sono adatti a garantire la piena sicurezza dell'operatore.

Marchio: C.P.1

Denominazione commerciale: FAST

Caratteristiche costruttive

- Tubi in acciaio S235JR.
- Compatibilità con ponteggio a tubo e giunti.
- Carico massimo 300 daN/m².
- Gamma completa di accessori.

Description

Scaffolding with a prefabricated frame with bushings, made of certified materials and under the strictest quality control.

Our narrow starting frame is only 35 cm wide and ensures an easy use even in the narrowest streets and spaces. Top guard rail elements of 1 and 2 m have inferior reinforcement with coupler to guarantee workers' total safety.

Mark: C.P.1

Commercial name: FAST.

Construction features

- Tubes in steel grade S235JR.
- Compatibility with tube-coupler scaffold.
- Admitted load 300 daN/m².
- Complete range of accessories.

Description

Échafaudage à cadres à douilles, construit avec des matériaux certifiés et sous strict contrôle de qualité.

Notre cadre de départ étroit mesure 35 cm de largeur, afin d'assurer un usage facile même dans les rues et les espaces les plus étroits.

L'élément garde-corps de 1 et 2 m a un renfort inférieur avec collier, pour garantir la sécurité des ouvriers.

Marque: C.P.1.

Nom commercial: FAST.

Caractéristiques techniques

- Tubes en acier S235JR.
- Compatibilité avec les échafaudages tubes et colliers.
- Charge maximale admissible 300 daN/m².
- Gamme complète d'accessoires.

Finiture

Verniciatura per immersione di colore rosso RAL 3009, zincatura elettrolitica o a caldo.

Norme di riferimento

Autorizzazione ministeriale protocollo 22707/PR7-B103 del 03/08/1979.

Voltura protocollo

15/VI/0020851/14.03.01.03 del 19/12/2005.

Estensione Ministeriale protocollo

15/VI/7246/14.03.02.02 del 23/10/2006.

Certificato croato.

Tubi: EN10219-1/2.

Zincatura a caldo: EN 40.

Zincatura elettrolitica: EN12329.

Finishes

Immersion painting in red colour RAL 3009, electrolytic or hot dip galvanization.

Reference standards

Italian Ministry authorization protocol

22707/PR7-B103 of 03/08/1979.

Turn to protocol 15/VI/0020851/14.03.01.03 of 19/12/2005.

Italian Ministry extension protocol

15/VI/7246/14.03.02.02 of 23/10/2006.

Croatian certificate.

Tubes: EN10219-1/2.

Hot dip galvanization: EN 40.

Electrolytic galvanization: EN12329.

Finissage

Peinture par immersion rouge RAL 3009, galvanisation électrolytique ou à chaud.

Normes de référence

Autorisation ministérielle

22707/PR7-B103 de 03/08/1979.

Transfert 15/VI/0020851/14.03.01.03 de 19/12/2005.

Extension ministérielle 15/VI/7246/14.03.02.02 de 23/10/2006.

Certification Croate.

Tubes: EN10219-1/2.

Galvanisation à chaud: EN 40.

Galvanisation électrolytique: EN12329.





Ponteggio a boccole C.P.1 FAST

Scaffold with bushings C.P.1 FAST

Cadre à douilles C.P.1 FAST

- Altezza telaio standard: 2,00 m
 - Profondità telaio standard: 1,05 m
 - Altezza mezza telaio: 1,24 m
 - Passo: 1,80 m
 - Profondità telaio partenza stretta: 0,35 m
- Height of the standard frame: 2,00 m
 - Width of the standard frame: 1,05 m
 - Height of the half frame: 1,24 m
 - Span: 1,80 m
 - Width of the narrow starting frame: 0,35 m
- Hauteur cadre standard: 2,00 m
 - Largeur cadre standard: 1,05 m
 - Hauteur demi cadre: 1,24 m
 - Longueur: 1,80 m
 - Profondeur cadre étroit de départ: 0,35 m

Telaio standard

Standard frame

Cadre standard

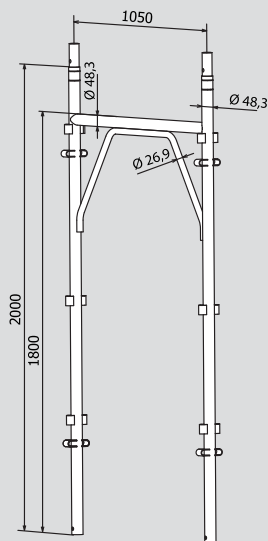

Mezza telaio

Half frame

Demi cadre

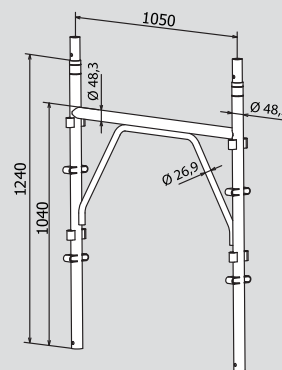

Cod.	Confezione	Peso/Kg
TEL2	50 pezzi con contenitore CONT1	20,50
	50 pieces with metal container CONT1	
	50 pièces liées avec panier CONT1	

Cod.	Confezione	Peso/Kg
TEL2M	Libera	15,50
	Free	
	Libre	

Corrente

Horizontal brace

Lisse

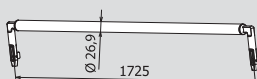

Diagonale di facciata

Diagonal brace

Diagonale

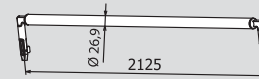

Cod.	Confezione	Peso/Kg
CORR2	100 pezzi	3,40
	100 pieces	
	100 pièces	

Cod.	Confezione	Peso/Kg
DIAG2	100 pezzi	3,60
	100 pieces	
	100 pièces	

Telaio partenza stretta inferiore

Narrow starting frame - lower element

Cadre étroit de départ - élément inférieur

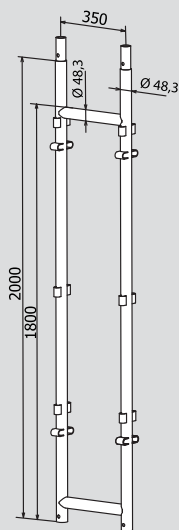

Telaio partenza stretta superiore

Narrow starting frame - upper element

Cadre étroit de départ - élément supérieur

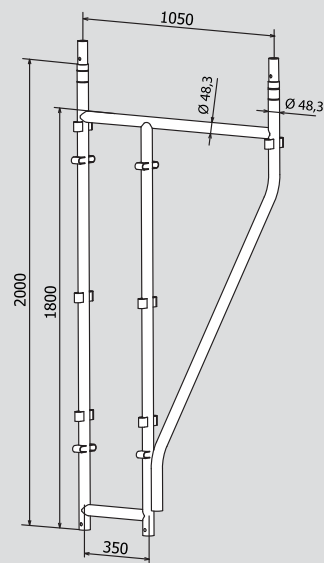

Cod.	Confezione	Peso/Kg
TEL2SI	Libera	19,00
	Free	
	Libre	

Cod.	Confezione	Peso/Kg
TEL2SS	Libera	26,30
	Free	
	Libre	

Terminale con giunto da 1 m

Top guard rail element of 1 m with coupler

Élément garde-corps de 1 m avec collier

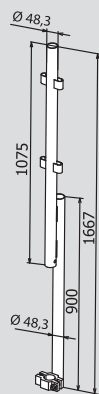

Terminale con giunto da 2 m

Top guard rail element of 2 m with coupler

Élément garde-corps de 2 m avec collier

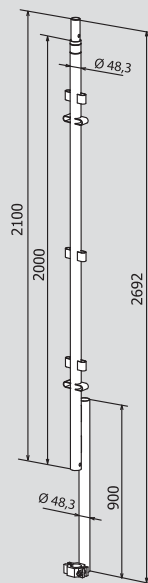

Cod.	Confezione	Peso/Kg
TER1B	20 pezzi	7,50
	20 pieces	
	20 pièces	

Cod.	Confezione	Peso/Kg
TER2B	20 pezzi	11,00
	20 pieces	
	20 pièces	

Diagonale in pianta

Plant view diagonal brace

Diagonale orizzontale

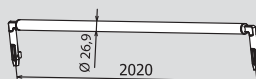

Cod.	Confezione	Peso/Kg
DIAG3	100 pezzi	3,50
	100 pieces	
	100 pièces	